

# CONQUEROR COOL ROOM PANEL

TECHNICAL SPECIFICATIONS AND PROFILES



Conqueror NZ Ltd has a policy of continuous product improvement; we reserve the right to change design or specifications without prior notice.



**CONQUEROR**

**Conqueror NZ Ltd** is New Zealand's only manufacturer of PIR foam core panel products on a continuous line.

From our state-of-the art 7500m<sup>2</sup> manufacturing plant in Christchurch we can manufacture a diverse range of panel products from a single production line, making it one of the most adaptable plants of its type anywhere in the world. This facility also has the unique ability to manufacture panels in lengths of up to 24m, enabling significantly more flexibility in building design.

### Quality and Durability

Conqueror panels are manufactured and tested to BS EN 14509 standards from the highest quality materials, using state of the art production equipment to rigorous quality control standards, ensuring long term reliability and service life.

### Warranty

In business, your reputation is everything and minimising risk makes sound business sense. Conqueror's range for thermal insulated cladding will give you the peace of mind you've chosen a quality material that conforms to relevant Australian and New Zealand standards and backed by a warranty you can count on.

Lead times are typically 2-3 weeks for stocked coatings and colours. Non stocked coatings/colours require extra lead time.

### Packaging and Delivery

Protective film is applied to the steel facing during the production process. Conqueror PIR panels are stacked flat. The number of panels in each pack depends on panel thickness.

Handling guidelines are available from Conqueror NZ Ltd Technical Services.

## WHY PIR CORE?

### ECONOMIC ADVANTAGES

Accelerated construction reduces site time and energy efficiency of PIR core, which can reduce operating costs by up to 50%.

### INSULATION PROPERTIES

Due to the low heat conductivity of its fully formed closed cell structure, PIR is thermally efficient. This superb thermal performance allows buildings to achieve premium levels of energy efficiency, with some of the thinnest available solutions.

### DURABILITY

As PIR does not sag or absorb moisture you can be confident of consistent performance which will last the full lifetime of the building.

### MOISTURE RESISTANCE

Water absorption through exposure to moisture or in exceptional circumstances through floods, is a significant factor with any modern insulation product. Due to having a closed cell structure, PIR is a hydrophobic product, meaning it does not absorb water. This allows the thermal performance and integrity of the product to be retained regardless of water exposure.

## STEEL FACING

### COLOURS

Our panels are available in the following colours. However, please note that the colour chart shown here is indicative only and is as close as the printing process allows. If in doubt before ordering, please refer to your Conqueror NZ Ltd agent's colour chart.

### COATING

The Zinc/Aluminium alloy coated steel has been formulated to give a significantly longer service life than a galvanized coating. This is of particular value in New Zealand where the prevailing winds carry corrosive salt-laden air many kilometers inland.

### FIRE RESISTANCE

PIR will self-extinguish as soon as the cause of fire is removed. PIR foam is a thermosetting material. It does not melt, flow or drip when exposed to fire and it will form a strong char that helps protect the foam core and prevent flame spread within the panels.

### OCCUPANT ADVANTAGES

- Passive temperature control for a more stable environment.
- Superior water, condensation and moisture proofing.
- Low allergenic qualities.
- Superior seismic performance.
- High fire rating for maximum inhabitant safety.
- Paint and steel finish option.
- Lifetime performance, with no deterioration of airtightness or insulation values.



## PRODUCT INFORMATION

Conqueror NZ Ltd's cool room panels are designed to be used for internal walls and ceilings, food processing facilities, clean rooms, pharmaceuticals, chillers / cool rooms and freezers. The simple male and female joint system allows for easy installation and is ideal for temperature-controlled environments. The panels can be installed horizontally or vertically and come in two distinctive profiles.



## PANEL PERFORMANCE

Thickness (mm)	50	75	100	150
R Value at 15°C (mK/W)	2.4	3.7	4.9	7.3
R Value at 23°C (mK/W)	2.3	3.5	4.7	7.7
Weight (kg/m <sup>2</sup> )	10.3	11.3	12.3	14.3
Unsupported Span (m)	3.0	4.3	5.0	5.5

Weight for 0.5/0.5 facings

## ACOUSTIC PROPERTIES

Freq	125	250	500	1000	2000	4000	STC	RW
Hz	16.1	17.5	19.2	23	32.2	36.8	20	23

Tested to ISO 10140-2 on 75mm panel.

## FIRE PERFORMANCE

AS1530.3 - Group 1-S	
Ignitability Index	0
Spread of Flame Index	0
Heat Evolved Index	0
Smoke Index	1
Fire Resistance Test: AS1530.4	--/130/30
Foam Plastic Core	
Core meets the requirements of AS1366.2	
External Radiation(ISO 5660-1:2015)	
AS1530.3 - Group 2-S	

## PRODUCT PROPERTIES

Core	Fire-retardant (PIR) foam
External facing	0.4mm thick Zinc/Aluminium G300S AZ150 coated steel to AS 1397
Internal Facing	0.4mm thick Zinc/Aluminium G300S AZ150 coated steel to AS 1397
Width	1000mm cover width or 1100mm available upon request
Length	As required, 2m - 24m
Thickness	50mm, 75mm, 100mm and 150mm

Other steel thicknesses and coatings upon request.

## PROFILE OPTIONS

Flat - Flat



Flat - Swaged



Swaged - Swaged

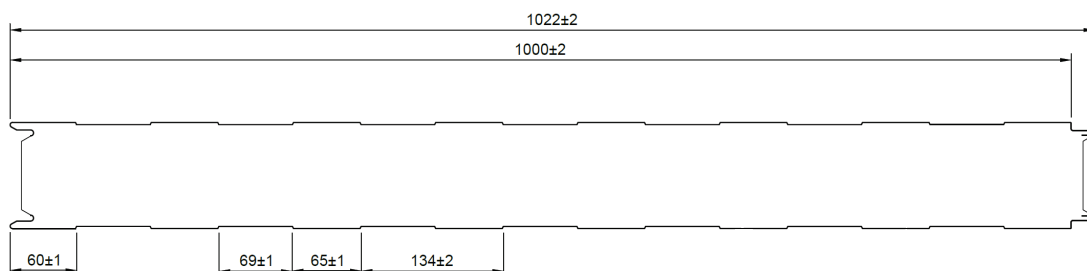
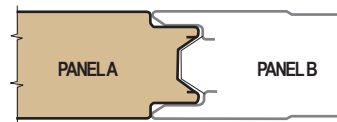

CD01 WALL TO GIRT FIXING

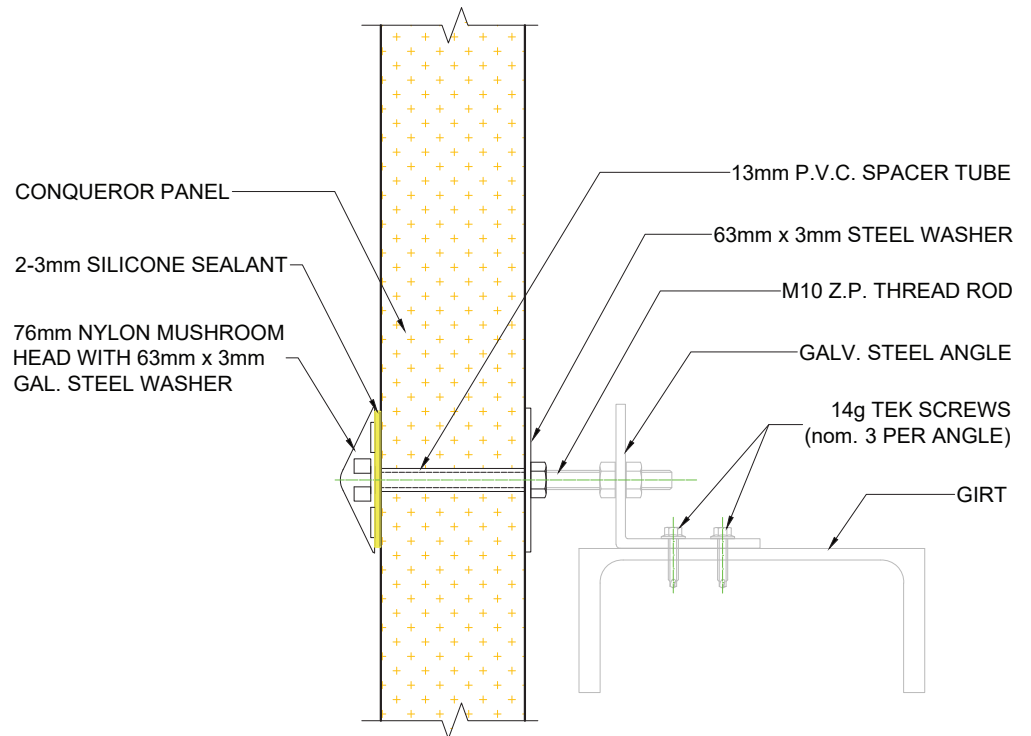

**NOTE:**

- FIXING MAY NEED TO BE VARIED TO ALLOW FOR THERMAL BOW OF WALL PANEL IN SOME CASES
- NUMBER OF GIRT FIXING PER PANEL VARIES WITH WIND LOADS REFER TO ENGINEER
- SEALANTS ARE REQUIRED IN SOME APPLICATIONS BUT ARE NOT SHOWN

CD02 EXTERNAL WALL BASE

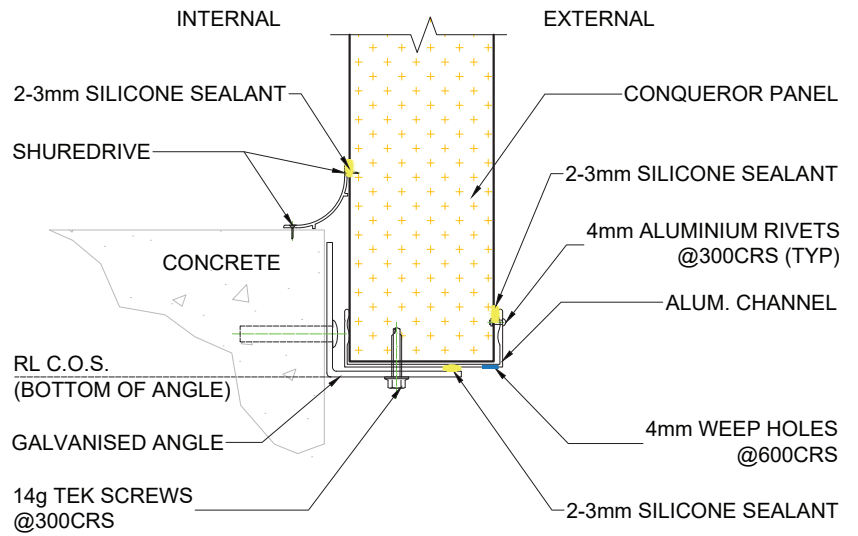

CD03 EXTERNAL WALL TO SHEET ROOF JOINT

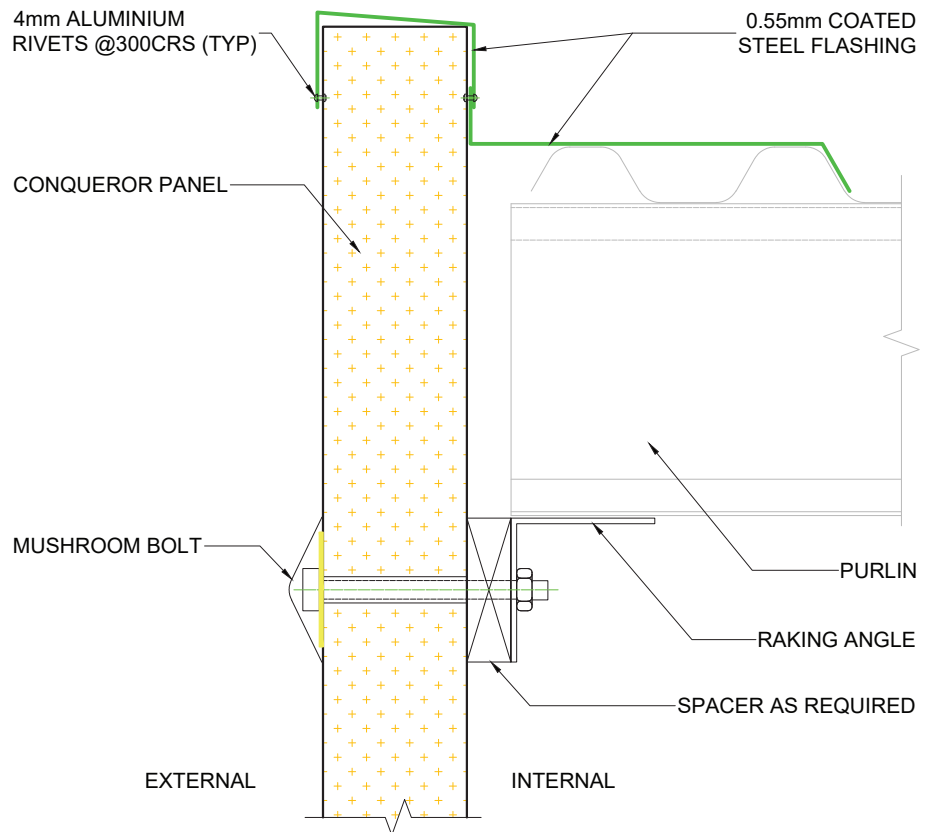

CD04 BASE DETAIL

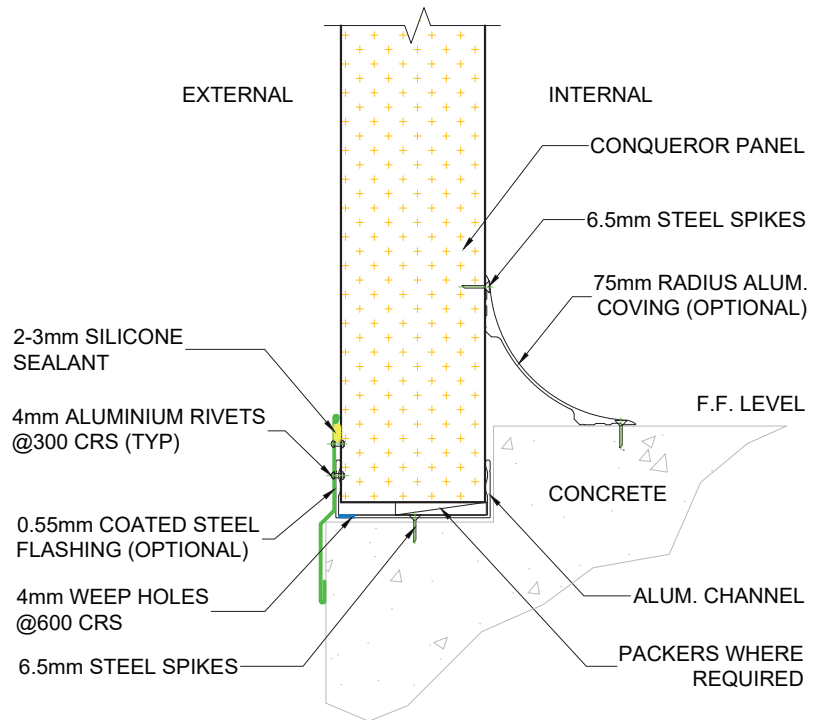

NOTE:  
SEALANTS ARE REQUIRED IN SOME APPLICATIONS BUT ARE NOT SHOWN



Lined writing area consisting of multiple horizontal red lines for text entry.

***CONQUEROR***

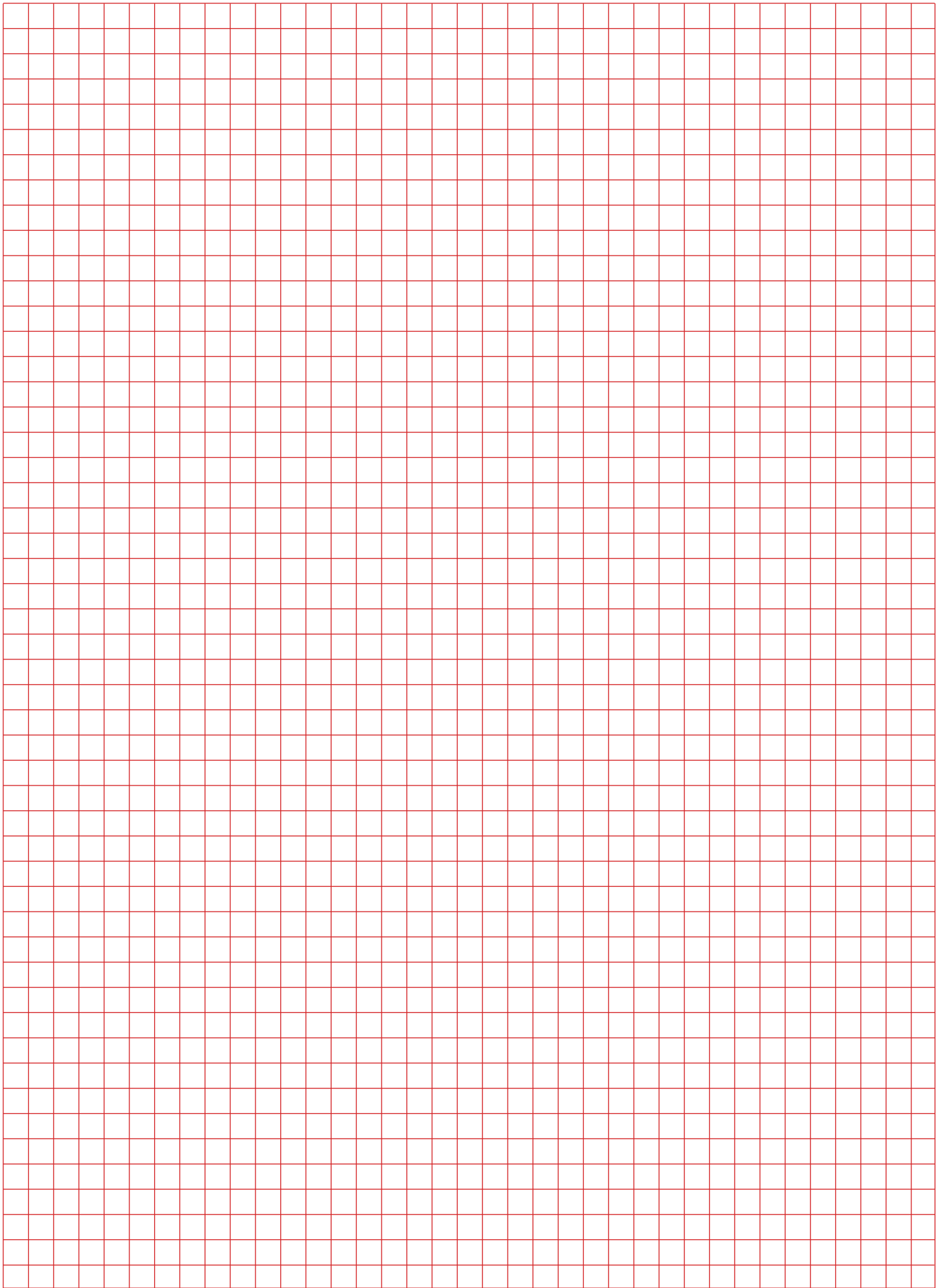

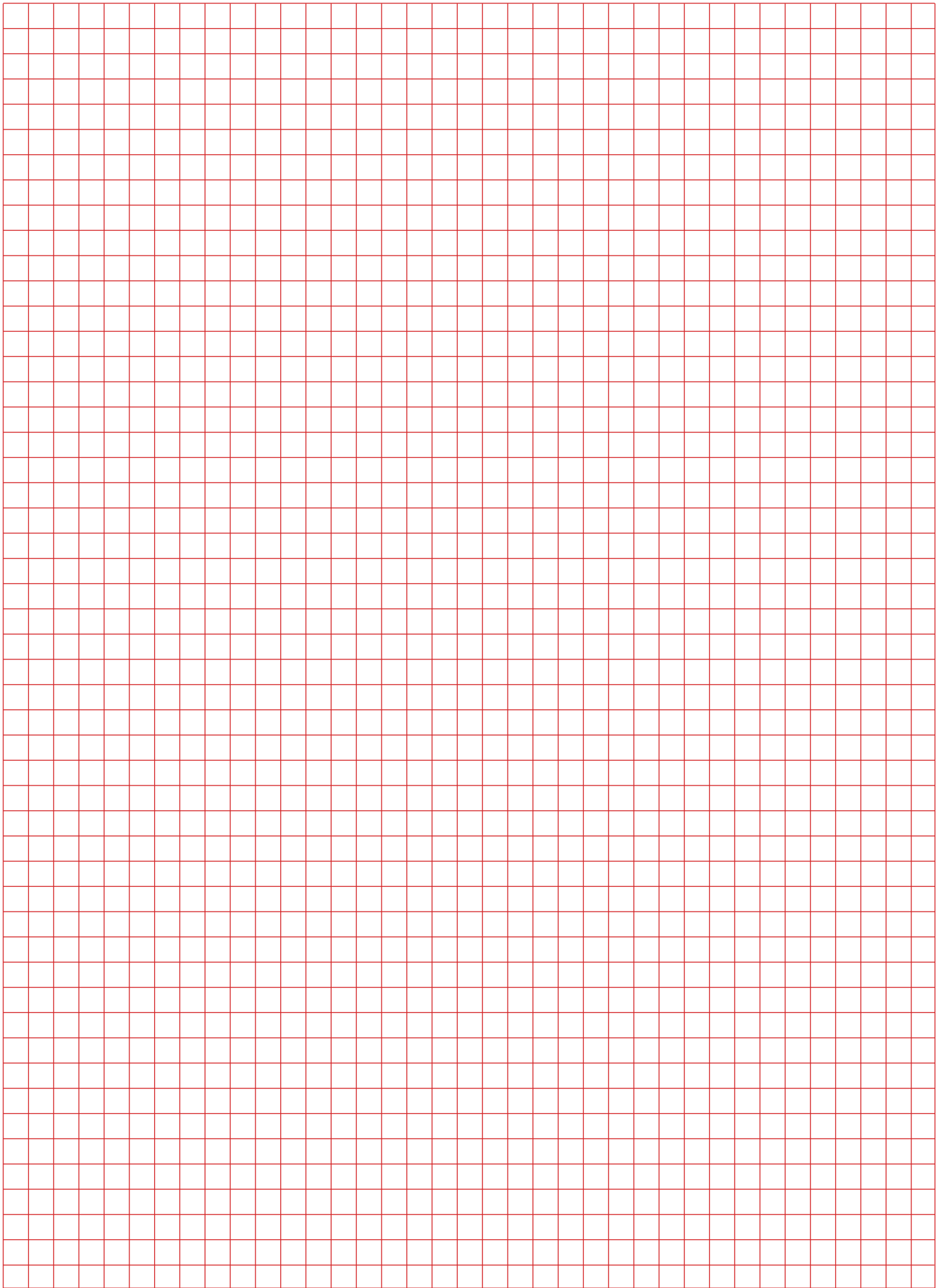

# CONTACT



**57 West Coast Road**  
Yaldhurst, Christchurch 7676



0800 799 923



[info@cnzltd.co.nz](mailto:info@cnzltd.co.nz)



[www.conquerornz.co.nz](http://www.conquerornz.co.nz)



[www.facebook.com/conquerornz](https://www.facebook.com/conquerornz)



[www.linkedin.com/company/conqueror-nz](https://www.linkedin.com/company/conqueror-nz)

**CONQUEROR**